

SELECTABLE LED SHOEBOX LIGHT

Wattages: 60W,90W,120W,150W;120W,180W,240W,300W



The Selectable LED Shoebox Lighting Series can be widely used for Outdoor Excellent for Parking Lots, Pedestrian Walkways, Roadways, Tennis Courts, Basketball Courts, Stadiums, Arenas, Schools, Residential Areas and many other applications.

**WATT/CCT
SELECTABLE**



Features:

- Optical design, greatly improved the light utilization and evenness
- High efficiency LED Driver, voltage AC120-277V/277-480V
- Cast Aluminum design, better cooling, light quality, LED Tj <85°C
- Photocell Control & Motion Sensor (Optional)
- 1-10V dimming (10%-100%) standard
- CCT:4000-5000K
- 5 years manufacturer warranty
- Compatible with most Lutron and Leviton dimmers

SPECIFICATION			
TYPE	#51565		#51566
WATTAGE	60W/90W/120W/150W		120W/180W/240W/300W
LUMEN	21021 lm(150W&4000K)		44714 lm(300W&4000K)
EFFICACY			> 145 lm/W
CCT			4000K,5000K
CRI			> 70
INPUT VOLTAGE			AC120-277V/277-480V
LIGHTING ANGLE			118°
FACTORY SETTINGS		150W & 4000K	300W & 4000K
LED TYPE			SMD2835
PF			> 0.98
DRIVER EFFICIENCY			> 90%
PROTECTION LEVEL			Wet location
LIFE TIME			> 75000 hours
WARRANTY			5 year limited

SELECTABLE LED SHOEBOX LIGHT

Wattages: 60W,90W,120W,150W;120W,180W,240W,300W

DIMENSION:

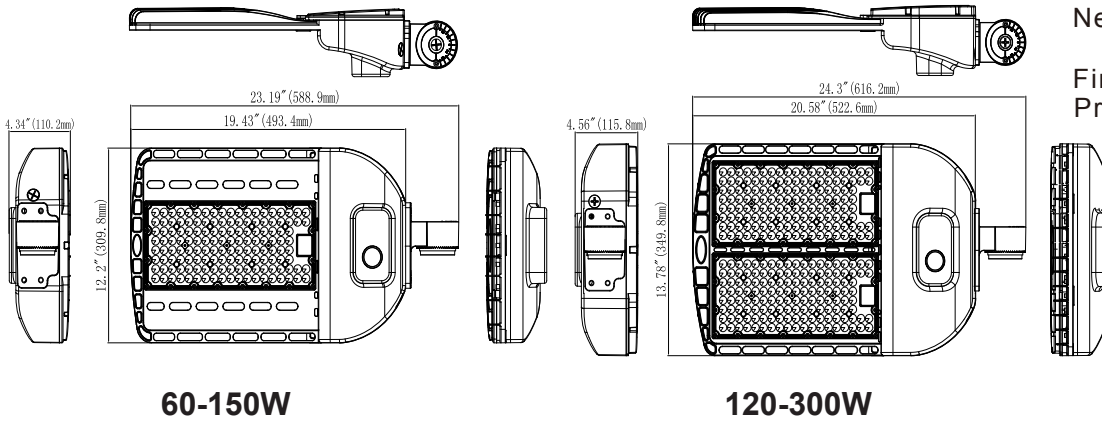

SPECIFICATIONS:

Shell materials: Aluminum & PC.

Net weight : 11.16 lbs (150W)

16.01 lbs (300W)

Finish: Dark Bronze(Standard)

Product Size:

150W:588.9X309.8X110.2(mm)

23.19"X12.2"X4.34"

300W:612.2X349.8X115.8(mm)

24.3"X13.78"X5.56"

MOUNTING OPTIONS:(SOLD SEPARATELY)



#51690

Arm Mount Square and Round poles) Standard versatile mounting arm is simple to install and can be used with existing poles for retro t installations.



#51693

Slipfitter Mount An optional cast aluminum mast arm adapter secures fixture head to nominal 2"(2-3/8"O.D. pipe size) horizontal steel tenon arm.



#51692

Wall Mount Wall Mount is easy to install for direct wall mounting with 1/2' conduit wiring mounting.

PHOTOMETRICS:

Type 2:

Type 2 optics produce a symmetrical pattern that evenly shines light on both sides of the lamp. In a back-to-back configuration, it creates a rectangular

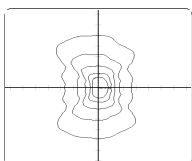

Type 3:

Type 3 optics produce an asymmetrical pattern that directs the majority of the light forward and equally on both sides of the luminaire. In a back-to-back configuration, it creates a rectangular pattern

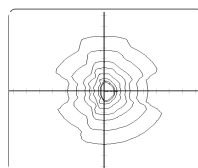

Type 4:

Type 4 is suitable for applications where light is primarily required forward with minimal backlight. Typical installations include perimeter poles.

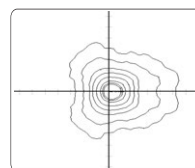

Type 5:

Type 5 optics produce a symmetrical square distribution pattern that distributes light equally on all sides of the luminaire. Type 5 luminaires is universal for most area lighting applications

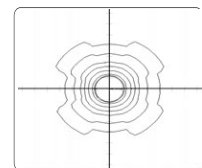

SELECTABLE LED SHOEBOX LIGHT

Wattages: 60W,90W,120W,150W;120W,180W,240W,300W







CONTROL MODULE:



WATT/CCT
FIELD-ADJUSTABLE

Simply select desired CCT and Wattage before installation

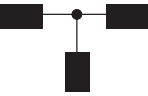
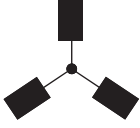
EPA OF AREA LIGHT

Item							
	1	2 @90°	2 @120°	2@180°	3 @90°	3 @120°	4 @90°
60-120W	0.641	1.282	1.481	1.382	1.923	1.743	2.564
150W	0.642	1.284	1.461	1.393	1.926	1.762	2.568
180-240W	0.644	1.288	1.466	1.376	1.966	1.768	2.576
300W	0.677	1.354	1.495	1.371	2.031	1.965	2.708

PERFORMANCE



SPECIFICATION

TYPE	#51565								#51566							
	60W (TYPEIII)		90W (TYPEIII)		120W (TYPEIII)		150W (TYPEIII)		120W (TYPEIII)		180W (TYPEIII)		240W (TYPEIII)		300W (TYPEIII)	
POWER	60W (TYPEIII)	90W (TYPEIII)	120W (TYPEIII)	150W (TYPEIII)	120W (TYPEIII)	180W (TYPEIII)	240W (TYPEIII)	300W (TYPEIII)	120W (TYPEIII)	180W (TYPEIII)	240W (TYPEIII)	300W (TYPEIII)	120W (TYPEIII)	180W (TYPEIII)	240W (TYPEIII)	300W (TYPEIII)
CCT	4000K	5000K	4000K	5000K	4000K	5000K	4000K	5000K	4000K	5000K	4000K	5000K	4000K	5000K	4000K	5000K
LUMENS	9000	8700	13050	12790	16680	16200	21021	20712	18720	17880	27180	26460	35280	34320	44714	43891
EFFICACY	> 150	> 145	> 145	> 140	> 140	> 135	> 140	> 135	> 155	> 150	> 150	> 145	> 145	> 140	> 145	> 140

SELECTABLE LED SHOEBOX LIGHT

Wattages: 60W,90W,120W,150W;120W,180W,240W,300W

PHOTOCELL & MOTION SENSORS (SOLD SEPARATELY)

	<p>Photocell #51140 Finish: Blue USE: Used for indoor or outdoor LED lamps, working with light sensing principle, the LC-10DT-74-X6 sensor (LC-10DT-74-X6 for 120-277V) is used for Light sensor.</p>		<p>SPECIFICATIONS AND CHARACTERISTICS:</p> <ul style="list-style-type: none"> • UL Listed. Reference No.: E178670 Volts & Cover Color • Blue standard for 120-277VAC • Turn-ON Light Level: 10-16 Lux • Turn ON/OFF Ratio: 1:1.5 to 3 • Time Delay: 2-10 sec • Operating Temperature: -40°C to +70°C • Relay: 15A • Energy Consumption: Less than 1Watt (120V<0.5W) • Electrical Life: >5000 cycles • Sensor Type: Silicon Photocell • Housing: UV stabilized PC • Failure Mode: Fail ON (standard), Fail OFF (for your option)
	<p>Motion Sensor #51141 Finish: White USE: The BR1823-B-D mounts in an outdoor lighting fixture and provides multi-level control based on motion. The sensor also includes a photocell to measure the ambient light level. It controls 0-10 VDC LED drivers, is rated for wet and cold locations. All control parameters are adjustable via a wireless configuration tool capable of storing and transmitting sensor profiles.</p>		

PHOTOMETRICS:

#51565 (150W,4000K,TypeII)

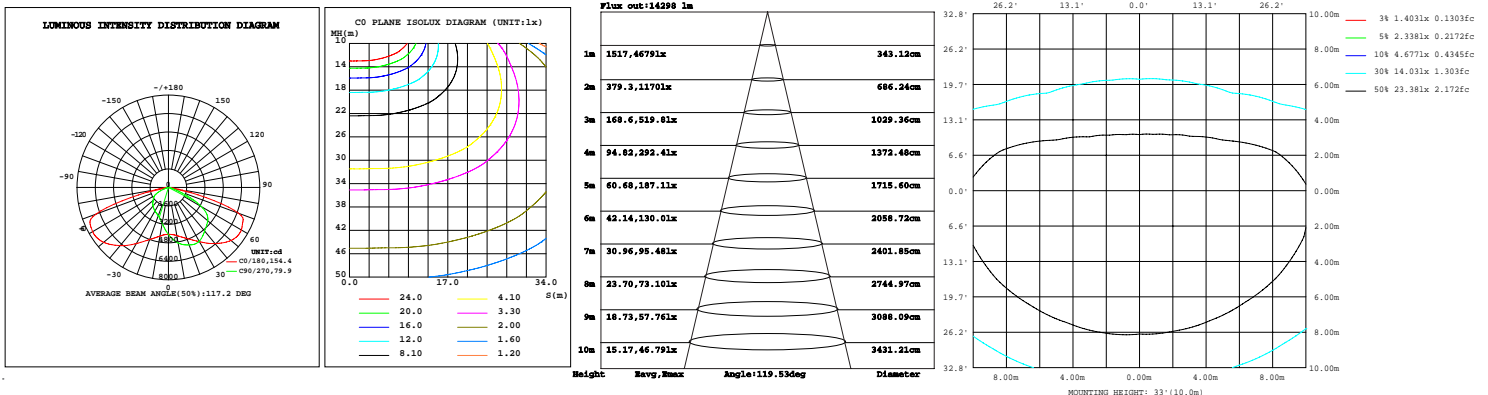

#51566 (300W,4000K,TypeII)

